

Operating instructions
Electronic pressure gauge
DMG S2601, DMG S2610



Translation from the German
© 2008–2010 Elster GmbH

Contents

Electronic pressure gauge 1
DMG S2601, DMG S2610..... 1
Contents 1
Safety..... 1
Checking the usage..... 2
 Type code..... 2
 Part designations..... 2
 Type label..... 2
Commissioning..... 2
 Segment displays 2
 Connecting the measuring hoses..... 2
 Selecting the operating mode 2
 ZERO (zero point calibration) operating mode .. 3
 UNIT (unit selection) operating mode 3
 AUTO (measured value resolution) operating mode..... 3
 Min./Max. measured value..... 3
 Hold function 3
 Display lighting..... 3
 Switching off 3
Maintenance..... 3
 Changing the batteries..... 3
Accessories 4
Assistance in the event of malfunction 4
Technical data..... 4
Declaration of conformity..... 4

Safety

Please read and keep in a safe place



Please read through these instructions carefully before installing or operating. Following the installation, pass the instructions on to the operator. These instructions can also be found at www.docuthek.com.

Explanation of symbols

- , **1**, **2**, **3**... = Action
- ▷ = Instruction

Liability

We will not be held liable for damages resulting from non-observance of the instructions and non-compliant use.

Safety instructions

Information that is relevant for safety is indicated in the instructions as follows:

⚠ DANGER

Indicates potentially fatal situations.

⚠ WARNING

Indicates possible danger to life and limb.

! CAUTION

Indicates possible material damage.

All interventions may only be carried out by qualified gas technicians. Electrical interventions may only be carried out by qualified electricians.

Conversion, spare parts

All technical changes are prohibited. Only use OEM spare parts.

Transport

On receipt of the product, check that the delivery is complete (see Part designations). Report any transport damage immediately.

Storage

Store the product in a clean, dry environment, protected from shocks. Ambient temperature: see Technical data.

Disposal

Components, particularly batteries, are to be disposed of separately.

On request, old units may be returned carriage paid to Elster GmbH in accordance with the relevant waste legislation requirements (for Germany: KrW-/AbfG [Act for Promoting Closed Substance Cycle Waste Management and Ensuring Environmentally Compatible Waste Disposal]).

Checking the usage

S2601, S2610

For measuring negative pressure, positive pressure, differential pressure and relative pressure of gaseous media in non-explosive areas.

This function is only guaranteed when used within the specified limits – see [Technical data – p. 4].

Any other use is considered as non-compliant.

! CAUTION

Please observe the following to ensure that the DMG is not damaged:

- Do not use the DMG in potentially explosive areas, or on people or animals.
- Note the max. medium and ambient temperatures, see [Technical data – p. 4].
- Protect the DMG against shocks and moisture.

Type code

Code	Description
DM	Electronic pressure gauge Measuring range
2601	0 to ± 150 mbar (± 2.18 psi)
2610	0 to ± 1000 mbar (± 14.5 psi)

Part designations

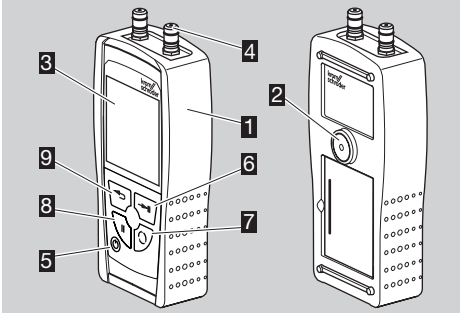

- 1** Measuring instrument including batteries and protective sleeve
- 2** Magnet
- 3** Display
- 4** Connections
- 5** On/Off button
- 6** Menu button/unit selection
- 7** Program selection button
- 8** Pause button
- 9** Min./Max. button



Type label

Model, serial number and measuring range: see type label.



Commissioning

Segment displays

- 1** Switching on the DMG: Press the On/Off button  for approx. 1 s.
 - ▷ All the available display segments are displayed for approx. 2 s. The segment display time can be extended for checking by keeping the On/Off button  pressed.

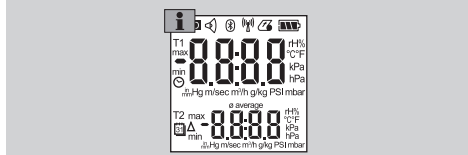

- ▷ The serial number, e.g. 0123, and the firmware version, e.g. 1.0.12, are displayed for approx. 2 s.

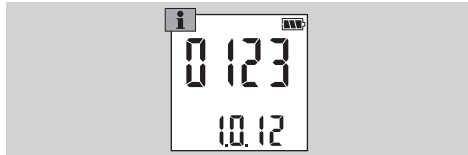

- ▷ The device type, e.g. 2601, and measuring range, e.g. 150 hPa, are displayed for approx. 2 s.

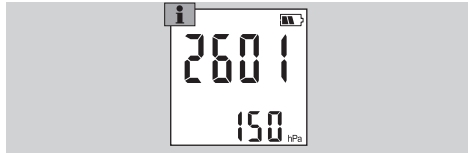

Connecting the measuring hoses

- ▷ The measuring hoses are available as a connection set, see [Accessories – p. 4].
- 1** Slide the measuring hoses onto ports P1+/P2-, depending on the appropriate field of application, and secure to the pressure test points.
 - Positive pressure: port P1+.
 - Negative pressure: port P2-.
 - Differential pressure: higher pressure at P1+, lower pressure at P2-.



- ▷ The unit is ready for operation.

Selecting the operating mode

- ▷ It is possible to change between the different operating modes using the program selection button .

ZERO (zero point calibration) operating mode

- ▷ In ZERO operating mode, the zero point can be set at any time and as often as required.

1 Press menu button →■.

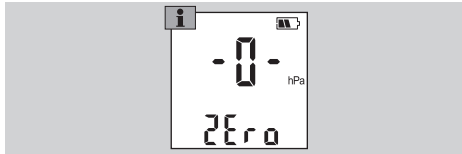

UNIT (unit selection) operating mode

- 1 Select the unit according to the measuring mode using the menu button →■.

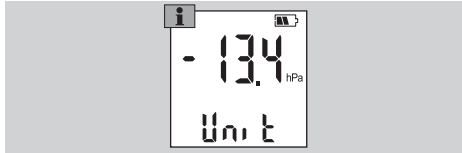

AUTO (measured value resolution) operating mode

- ▷ Availability of this operating mode is dependent on the measuring ranges.
- ▷ In AUTO operating mode, the best possible display of the measured value is pre-set automatically. The resolution is thus adjusted or reduced as the measured value increases.

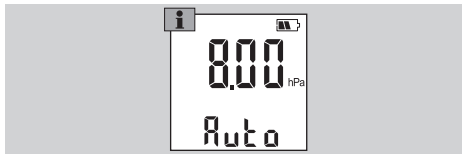

- ▷ The desired measured value display can be pre-set manually using the menu button →■, so that irrelevant digits after the decimal point, for example, can be masked.

Auto: automatic measuring range selection,
Lo (Low): low measuring range (higher resolution),
Hi (High): high measuring range (low resolution).

Min./Max. measured value

1 Press min./max. button ←◀.

- ▷ The display shows the minimum measured pressure value.

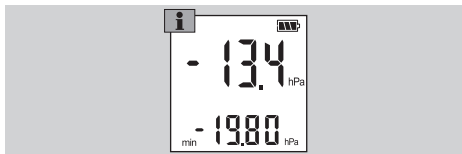

2 Press min./max. button ←◀ again.

- ▷ The display shows the maximum measured pressure value.

3 To delete the min./max. measured value, press the menu button →■.

- ▷ The current measured pressure value is displayed again.

Hold function

- ▷ In all operating modes, the measured value can be held by pressing the pause button ||.

▷ **HOLD** appears in the top left corner of the display.

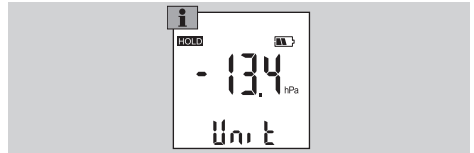

- ▷ By pressing the pause button || again, the measured value is released.

Display lighting

- ▷ The display lighting can be switched on and off by briefly pressing the On/Off button (⏻).

Switching off

- ▷ Press the On/Off button (⏻) for approx. 2 seconds.
- ▷ Automatic time-dependent switch-off is currently not implemented.

Maintenance

- ▷ It is recommended that you have the instrument checked regularly (< 24 months) and that it be recalibrated regularly if used industrially.

Changing the batteries

- ▷ Approved batteries, see [Technical data – p. 4].
- ▷ The charge status is displayed in the top right corner of the display.



- ▷ Always change both batteries at the same time.

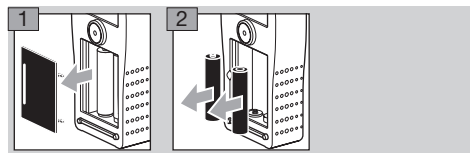

3 Insert new batteries.

4 Ensure that these are connected with the correct polarity.

5 Place the cover back on the battery compartment to close.

6 Dispose of used batteries separately.

Accessories

- ▷ Connection set:
 - 2 x blue plastic hoses, 3 x 0.5 mm,
 - 2 x silicone hoses, 5 x 2 mm,
 - 2 x hose connectors D3/D5.

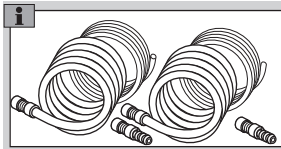

- ▷ Order No.: 03352147.

Assistance in the event of malfunction

- ? **Fault**
- ! **Cause**
- **Remedy**

- ? The DMG will not switch on.
- ! The battery charge is too low.
- Change batteries.

- ? Pressure is not displayed.
- ! The sensor is defective.
- Return unit to the manufacturer.

Technical data

Dimensions including protective sleeve W x H x D:
66 x 37 x 143 mm (2.7 x 1.4 x 5.6").

Weight: approx. 250 g (8.8 oz).

Housing: plastic, blue,
protective sleeve: plasticized PVC.
Display: transreflective.

Response delay: 90% (T 90) of the measured
value will appear on the display within 10 s.

Ambient and medium temperatures:
0 to +40°C/+32 to +104°F,

storage temperature:
-20 to +50°C/-4 to +122°F.

Approved batteries: 2 x 1.5 V (type miniature
LR6/AA).

Power supply: rated voltage via power adapter
(USB).

DMG 2601 measuring range:
rated 150 mbar (2.2 psi), max. 180 mbar (2.6 psi),
max. positive pressure: 1.35 bar (19.6 psi).

DMG 2610 measuring range:
rated 1000 mbar (14.5 psi), max. 1500 mbar
(21.8 psi), max. positive pressure: 3 bar.

Resolution:

DMG 2601: 0.01 (< 19.99); 0.1 (> 20),

DMG 2610: 0.1 (< 199.9); 1 (> 200).

Accuracy [% of measured value]:

DMG 2601:

1 ± 1 digit (< 130 mbar/1.9 psi);

1.5 ± 1 digit (> 130 mbar/1.9 psi).

DMG 2610:

1 ± 1 digit (< 1000 mbar/14.5 psi);

1.5 ± 1 digit (> 1000 mbar/14.5 psi).

Enclosure: IP 40 EN 60529

Declaration of conformity



We hereby declare that the products DMG 2601
and 2610 comply with the requirements of the listed
Directives and Standards.

Directives:

– 2004/108/EC

Standards:

– EN 55022

– EN 61000-6-1

– EN 61000-4-2

– EN 61000-4-3

The production is subject to a Quality System pursu-
ant to DIN EN ISO 9001.

Elster GmbH

Scan of the Declaration of conformity (D, GB) – see
www.docuthek.com

Contact

If you have any technical questions, please contact
your local branch office/agent. The addresses are
available on the Internet or from Elster GmbH.

We reserve the right to make technical modifications
in the interests of progress.

elster
Kromschroder

Elster GmbH
Postfach 28 09, D-49018 Osnabrück
Strothweg 1, D-49504 Lotte (Büren)

T +49 541 1214-0

F +49 541 1214-370

info@kromschroeder.com, www.kromschroeder.com